

# Operating manual

## Moving Flash



©2015 Machines Highest Mechatronic GmbH, Erl, Austria

**Content:**

1.	Safety Instructions.....	2
1.1.	Personal protective equipment .....	3
1.2.	Safety instructions for the operating staff .....	3
1.3.	Additional risks .....	4
2.	Technical data .....	5
3.	Construction.....	5
3.1.	Base frame.....	6
3.2.	Height Adjustment .....	6
3.3.	Linear axis .....	7
3.3.1.	Motor.....	7
3.3.2.	Stroke length adjustment.....	7
3.3.3.	Linear slide.....	7
3.4.	Dryer Box .....	7
3.5.	Control unit.....	8
4.	Operating the machine .....	8
4.1.	Display.....	8
4.1.1.	State.....	9
4.1.2.	Sensor position.....	9
4.1.3.	Speed.....	9
4.1.4.	SW Revision .....	9
4.1.5.	Step Cnt.....	9
4.2.	Keys.....	10
4.3.	Parameter menu .....	10
4.4.	Stopping the machine in emergencies .....	11
5.	Maintenance of the dryer .....	11
6.	Terms of the Guarantee.....	12
7.	Limitation of liability .....	12
8.	Support, Customer Service and Hotline.....	12

**1. Safety Instructions**



The machine is built according to the state of the art and in accordance with all appropriate safety regulations. Owing to its complex design, the machine must only be operated and maintained by appropriately skilled staff.

All procedures should only be carried out by properly trained and appropriately qualified personnel. ‘Qualified personnel’ refers to people who are able to carry out the required procedures and to recognize as well as prevent potential risks, as a result of their training, experience and instructions. Such personnel should have a good knowledge of any relevant standards, regulations, rules of accident prevention and internal conditions etc.

## 1.1. Personal protective equipment





Personal protective equipment must be used at work. This equipment comprises close-fitting working clothes with tight sleeves and high tearing resistance without any protruding parts. These features prevent operators from getting caught by moving machine parts.

## 1.2. Safety instructions for the operating staff

 <p style="text-align: center;"><b>DANGER</b></p>	<p>All cabinets and covers on the dryer must always be kept closed. Open cabinets and covers are extremely dangerous as live electrical components are accessible.</p>
	<p>Mechanical or electrical failures must only be repaired by an MHM authorized/approved technician.</p>
	<p>On every occasion, the operator should check the correct functioning of the safety devices (Emergency STOP), before commencing use of the dryer.</p>
	<p>No modifications to any part of the machine or its assembly system that may adversely affect safety must be carried out without the prior approval of MHM.</p>
 <p style="text-align: center;"><b>CAUTION</b></p>	<p>Program modifications in the control program and changes of settings which may affect the dryer's operation should only be carried out by an MHM authorized/approved technician.</p>
	<p>All working spaces, passageways, escape and emergency routes and exits must be kept clear.</p>
	<p>No tools or other objects must be kept or left in the area of the machine.</p>
	<p>Any modifications or changes to the dryer's settings should only be carried out by an MHM authorized/approved technician.</p>
 <p style="text-align: center;"><b>NOTE</b></p>	<p>Always wear protective gloves and safety goggles during cleaning work, in particular when using solvents!</p>
	<p>Any remains of potentially harmful substances should be disposed of according to the legal requirements of the country or state in which the dryer is operated.</p>
	<p>All accessories for service and maintenance work (e.g. cleaning agents) must be collected in suitable containers and disposed of according to any relevant regulations.</p>

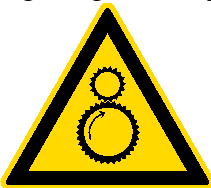
### 1.3. Additional risks

Even though the machine has been designed and built according to the most stringent safety criteria, as with all machinery we have to anticipate certain additional risks, which are detailed below:

Danger	Description	Behavior/Action
Mechanical threats: Crushing 	Crushing of parts of the body - in particular arms and hands.	Be aware of moving parts whilst operating the machine. Wear protective clothing at all times.
Mechanical threats: Getting caught or trapped 	Danger through moving parts (linear or rotary drive systems).	Danger in reaching into, under or over the machine. Only reach into the machine from the indicated points. Wear appropriately fitting clothes, particularly in the area of the arms.
Mechanical threats: Slipping, stumbling and falling 	Danger of falling (e.g. over obstacles on the floor).	The floor area around the machine must be kept free from any obstacles.
Electrical threats: Indirect contact (in case of defect) 	Danger of life-threatening electrical shock by indirect contact with defective parts carrying voltage (in particular in case of defective insulation).	Unplug machine from power supply! Contact electrician for fault removal.
Danger through contact with or inhaling of substances 	Danger through contact with or inhaling substances or materials with harmful or toxic effects.	Observe the safety instructions for handling such substances.

## 2. Technical data

Description	Requirement/Value
Electric supply	3x 400V; 50/60Hz; ±5%
Power consumption	11 kW
Dimensions (W/D/H)	100 x 200 x 175 cm
Weight of the machine	180 kg
Packaging weight	360 kg
Max. drying area	80x150 cm

## 3. Construction

The main components of the machine are the moveable base frame with height adjustment, the linear axis, the dryer box and the control unit.



### 3.1. Base frame

The base frame is equipped with rolls for easy transport.



All four rolls must be locked before starting the production. Unlocked rolls may result in danger to persons or material damage to the machine through unexpected movement.

### 3.2. Height Adjustment

At uneven grounds it is necessary to adjust the distance between dryer and pallet of the print machine. Use the four adjusting wheels to adjust height and tilt. The distance between upper edge of the pallet and lower edge of the dryer box must be **30mm**.

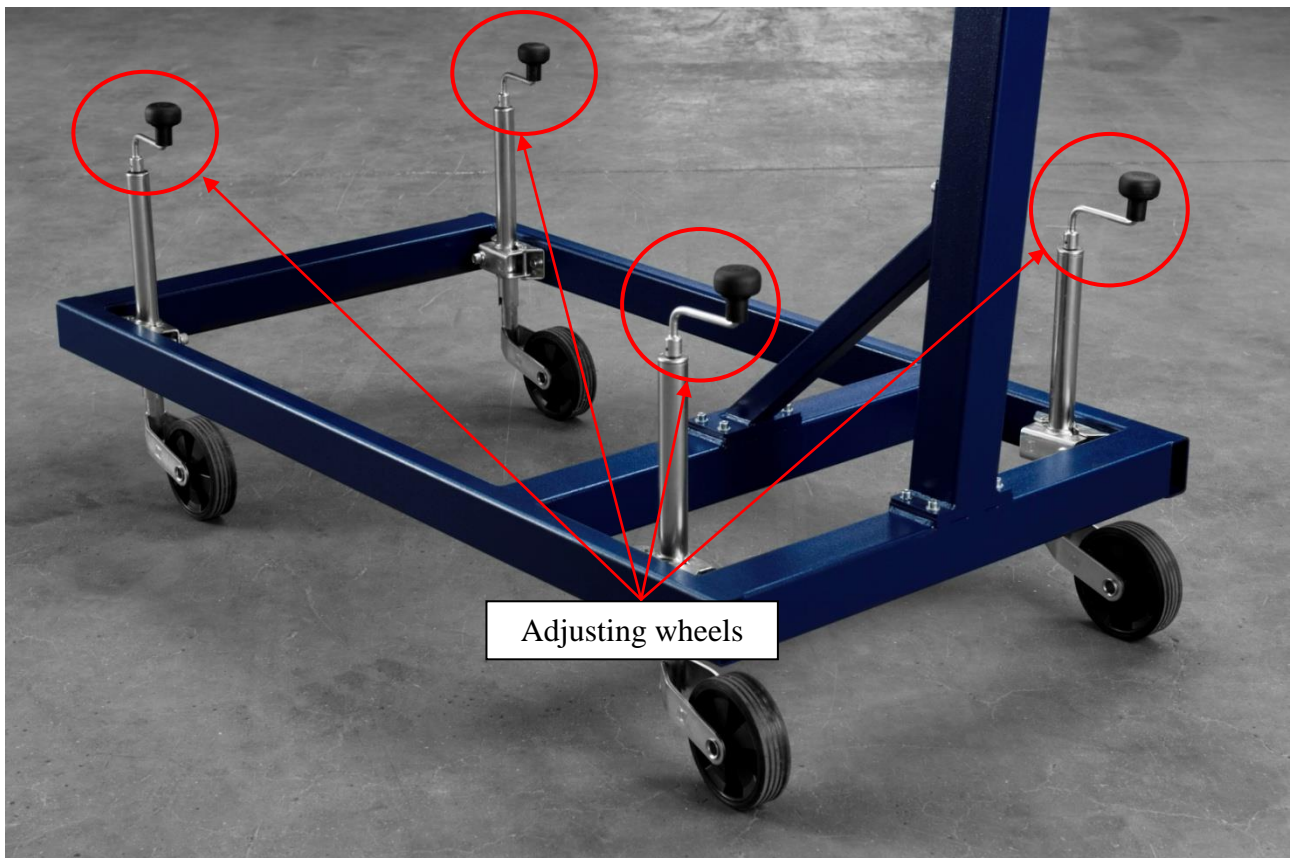

### 3.3. Linear axis

On the linear axis the following components can be found:

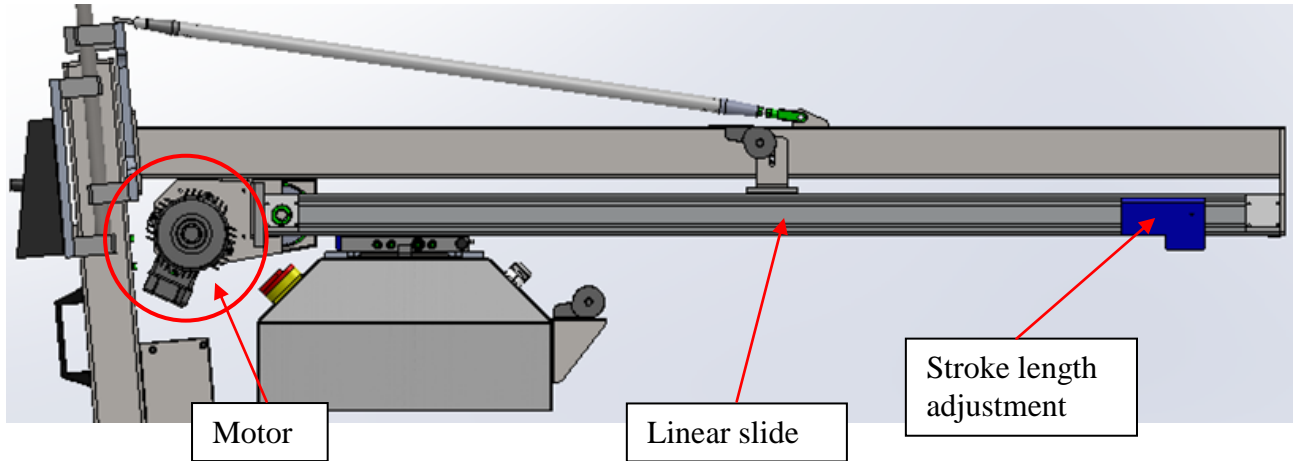

#### 3.3.1. Motor

The motor moves the linear slide forward and backward.

#### 3.3.2. Stroke length adjustment

The stroke length adjustment may be used to adjust the precise travel of the dryer. There are individual sensors to adjust the front and rear positions. Minimizing the travel of the dryer helps to reduce drying time and increase production.

#### 3.3.3. Linear slide

Special closed linear slide for a long lifetime.

### 3.4. Dryer Box

The dryer Box is attached to the linear slide. At the dryer box it is possible to adjust the drying power and the maximum drying time.

### 3.5. Control unit

At the control unit the actual state of the dryer can be seen on the display. Various keys are available for controlling the moving flash.



## 4. Operating the machine

### 4.1. Display





#### 4.1.1. State

Below the headline you can see the actual state of the dryer. The following states are possible:

- Ready to start  
Dryer waits for start signal.
- Dryer active  
Drying is in progress.
- Clean  
Dryer moves to clean position.

#### 4.1.2. Sensor position

The third line shows the position of the dryer. The following messages are possible:

- Wait for START  
Dryer is in front or rear start position and can started by a signal from the machine.
- Dryer not on position  
Dryer is not in front or rear start position. Move dryer or adjust stroke length adjustment.
- Both sensors active  
Front and rear position sensors are active. Dryer will not move. Adjust stroke length adjustment when necessary.

#### 4.1.3. Speed

Actual speed for dryer movement. Use the keys left and right to adjust speed from 10 to 25%. This is only for temporary adjustment. To safe speed go to parameter menu and set value there.

#### 4.1.4. SW Revision



Shows actual software revision.

#### 4.1.5. Step Cnt

Shows actual position in software for debugging.

## 4.2. Keys

The following functions are available from the control keypad:

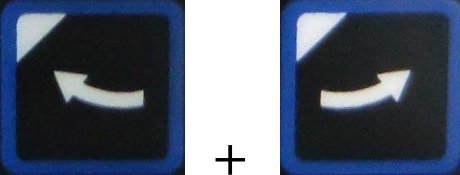
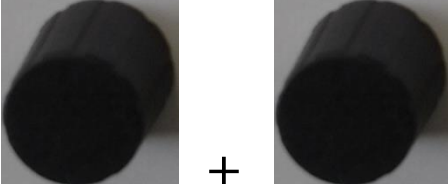
Key	Function
	Use ADJUST to exit parameter menu.
	With the button clean the dryer will automatically move to the front position.
	Use the keys left and right to adjust speed from 10 to 25%. This is only for temporary adjustment. To safe speed go to parameter menu and set value there.
	To activate the parameter menu the right turning knob has to be held and the left turning knob has to be pushed.

## 4.3. Parameter menu

To activate the parameter menu the right turning knob has to be held and the left turning knob has to be pushed. The following parameters can be edited:

- Flash Speed  
Adjust Flash movement speed. Values between 10 and 25% are possible.  
Default: 20 %
- Stroke Count  
Determines the number of strokes the moving flash will make.  
Default: 2
- Init Move  
Determines what the moving flash will do if it is not on start position:  
0...dryer will not start  
1...dryer will move to back position and starts afterwards  
2...dryer will move to front position and starts afterwards  
Default: 2
- Heat up time  
Start delay for movement to give lamps time to heat up. Enter in 1/10 of a second.  
Default: 5 (0,5s)

- Stop delay  
Stop delay for movement to give motor time to brake. Enter in 1/10 of a second.  
Default: 2 (0,2s)
- Timeout [s]  
Maximum drying time. After this time dryer will stop. Enter in seconds  
Default: 35 seconds
- LCD Contrast  
Adjust LCD Contrast.  
Default: 32
- LCD Color  
Adjust LCD Color.  
Default: 3

To change a parameter value, first scroll to the respective parameter with the left turning knob and select it by pressing the left turning knob. Turn the right knob to change the value, to save the value press the right turning knob. Use the ADJUST key to exit the parameter menu.

#### 4.4. Stopping the machine in emergencies

Pressing an emergency stop push button on the machine will also stop and deactivate the moving flash.

### 5. Maintenance of the dryer

The dryer has been designed to operate ‘maintenance-free’ as far as possible. Only a few important service measures are necessary by the operator.

Task	Frequency	Comment/Action
Daily cleaning	Daily	Remove all residues from the dryer remaining from production materials such as inks and adhesives etc. Clean, tidy and sweep the print shop area.
Wipe clean the sealing band on the underside of the linear profile	Weekly	The sealing band on the underside of the linear profile must be wiped clean thoroughly and lubricated with an oil-soaked cloth.

Sealing band on the underside of the linear profile

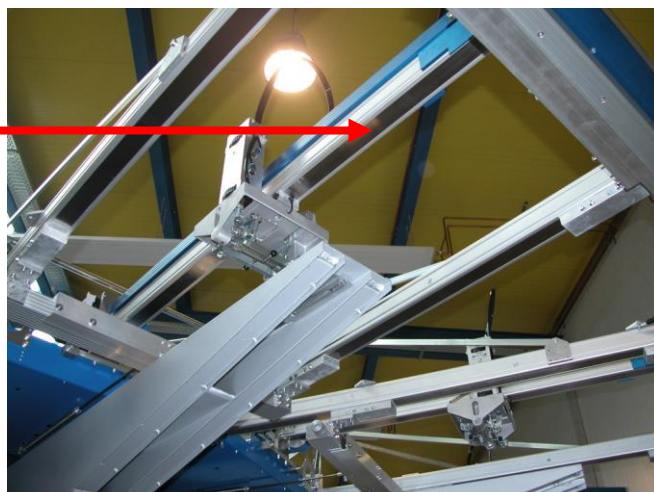

## 6. Terms of the Guarantee

The terms of the guarantee are detailed in the General Terms and Conditions of Machines Highest Mechatronic GmbH.

## 7. Limitation of liability

Warranty and liability claims for personal injury and material damage are **excluded** if they can be attributed to or are a result of one or several of the following:

- Improper use of the dryer.
- Incorrect assembly, operation or maintenance of the dryer by the operator.
- Operation of the machine with defective safety devices and/or safety devices which are missing / removed or not in correct working order.
- Failure to comply with the safety instructions in this document with regard to transportation, assembly, start-up, installation, operation, control and maintenance of the dryer.
- Failure to comply with the Operating Instructions.
- Unauthorized modifications to the dryer (e.g. disassembly of original MHM components and/or use of any non-original MHM components)
- Unauthorized modifications to any part of the drive or control systems (e.g. change of control components or frequency converters).
- Lack of monitoring and maintenance of machine parts/components subject to wear and tear.
- Repair measures, maintenance or service work carried out by unauthorized persons.
- Use of lubricants other than those recommended by MHM.
- Operation of the machine under technical conditions other than those specified by MHM (e.g. excessive power supply voltage and/or excessive air pressure).
- Damage by any foreign object and/or force majeure.
- Omission of specified maintenance, service measures and procedures.
- Operation of the dryer by untrained personnel.

## 8. Support, Customer Service and Hotline

In case of any problems or additional questions please turn to your appropriate service partner.